

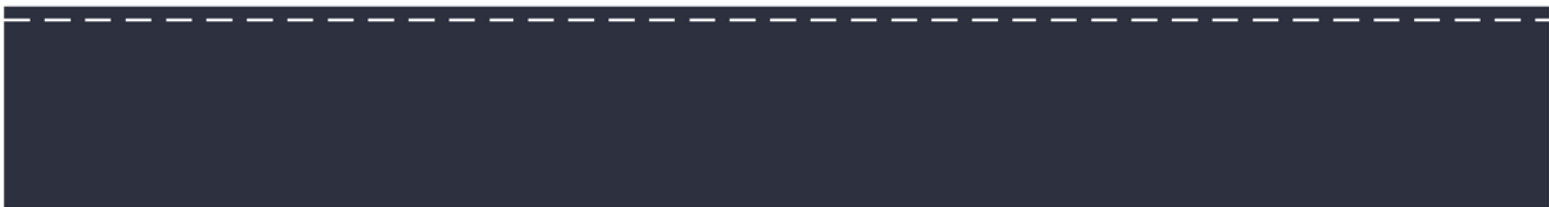

ALWAYS THE
SAFE CHOICE!



Door & Window Equipment



Door Chains & Door and Window Security



TK 64

Security door chains with screws

TK 64

The door chain with built-in spring to prevent accidental opening, approx. chain length 16 cm.



Art.-No.		EAN		Colours
		40 03482...		
TK 64	SB	05481 9	5	nickel-plated
TKM 64	SB	05501 4	5	brass-plated
TKB 64	SB	05511 3	5	antique copper finish



TKM 75

TK 75

Luxury door chain with built-in spring to prevent accidental opening, approx. chain length 15 cm.



Art.-No.		EAN		Colours
		40 03482...		
TK 75	SB	05521 2	5	nickel-plated
TKM 75	SB	05531 1	5	brass-plated
TKB 75	SB	05541 0	5	antique copper finish



VTK 90

VTK 90

Key-operated door chain for doors and windows, extra strong, with edge protection, approx. chain length 18 cm.



Art.-No.		EAN		Colours
		40 03482...		
VTK 90	SB	05341 6	3	nickel-plated

Alarm for doors and windows



FTA 2005

- suitable for all windows and doors with hinge or sliding function
- 100dB high-performance alarm
- low battery consumption
- batteries included
- easy assembly
- WEEE reg no. DE19767115



Art.-No.		EAN		Colour
		40 03482...		
FTA 2005	SB	14181 6	5	white



NEW

Personal alarm



PA 2006

- ideal for joggers, elderly, ...
- fits into pocket and on the key ring
- 100dB high-performance alarm
- low battery consumption
- batteries included
- WEEE reg no. DE19767115



Art.-No.		EAN		Colours
		40 03482...		
PA 2006	SB	14191 5	10	assorted





TS 1500 S

Door closer TS 1500

The "little" with the technology of the "big ones"

- compact rack-door-closer in size 3/4 for doors from 95 to 110 cm
- force and grade of closing easily adjustable through turning of the gear block
- speed and final latching adjustable
- tested and manufactured according to DIN EN 1154
- 5 years warranty

Art.-No.	EAN	H x W x D	Colours	
	40 03482...	mm		
TS 1500 S	19750 9	50 x 177 x 40	silver	1

Art.-No.		
TS 1500	< 95 + 110 cm	< 130 kg

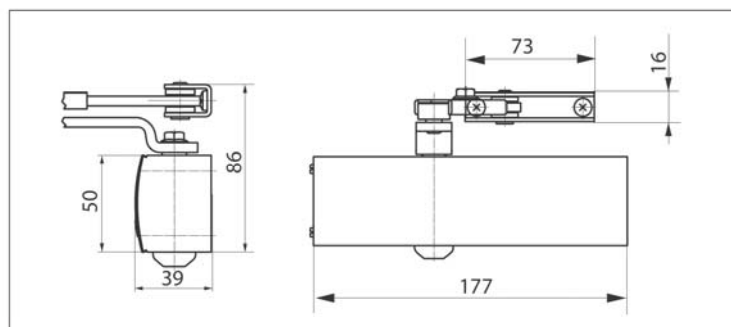



TS 2000 V S

Door closer TS 2000 V

Rack-door-closer with variable closing force up to 125 cm door width

- closing force variable by means of offset mounting (size 3/4/5) for door widths up to 95, 110 and 125 cm 
- top-design, easy assembly
- closing speed adjustable from the front
- final latching adjustable through the gear and closing speed
- independent from temperature
- tested and manufactured according to DIN EN 1154
- 5 years warranty

Art.-No.	EAN	H x W x D	Colours	
	40 03482...	mm		
TS 2000 V S	SB 15121 1	60 x 226 x 50	silver	2

Art.-No.		
TS 2000 V	< 95, 110 + 125 cm	< 160 kg

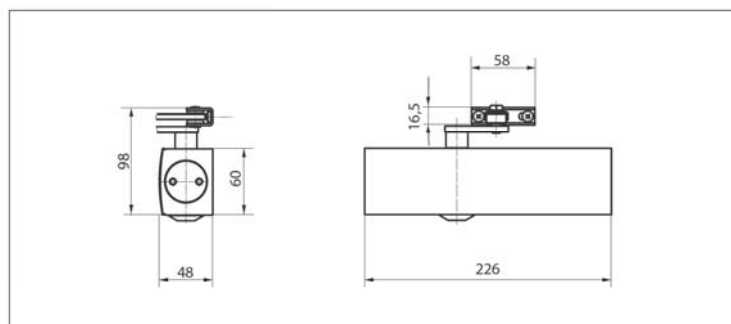

Door Closers





TS 504 S

Door closer TS 500

- reliable and productive
- hydraulically steered
- final latch, final speed and closing speed adjustable
- incl. assembly instructions, template and fixing material
- 3 years warranty



Art.-No.	EAN	H x W x D	Colours	
	40 03482...	mm		
TS 504 S	SB	17521 7	50 x 200 x 41	silver 2

Art.-No.		
504	< 110 cm	< 80 kg





GTS 514 S

Door closer GTS

- hydraulic door closer
- adjustable closing speed and final latch
- hold-open arm included
- the elegant alternative: door closer with slide bar
- slide bar: 425 mm
- 3 years warranty

Art.-No.	EAN	H x W x D	Colours	
	40 03482...	mm		
GTS 514 S	SB	18520 9	50 x 200 x 41	silver 1

Art.-No.		
514	< 110 cm	< 80 kg



TR 86 W

In-door closer

Reliable functioning, unobtrusive installation



Art.-No.	EAN	H x W x D	Colours	
	40 03482...	mm		
TR 86 W	SB	08661 2	17 x 400 x 34	white 5



TF 125 Ni

Doorstop TF Ni

- well designed
- stainless steel appearance
- with screws
- stroke:
TF 125 Ni = 25 mm



Art.-No.	EAN		Colours
TF 125 Ni	40 03482... 15741 1	5	stainless steel appearance



TH 68

Door lifter

- with screws
- stroke adjustable from 9 to 15 mm



Art.-No.	EAN		Finition
TH 68	40 03482... 05431 4	5	nickel-plated

Doorstops

Doorstop 'Puck'

- flexible utilisation
- no screwing necessary
- heavy stainless steel quality
- wide rubber rings for careful and secure stopping
- height 40 mm, Ø 80 mm
- weight 1120 gr

Art.-No.	EAN	Colours
2580 Ni	40 03482... 15600 1	1 stainless steel



PUCK 2580 Ni

Doorstop

- no screwing necessary
- flexible utilisation
- solid marble
- rubber rings and rubber pad for careful and secure stopping
- height 40 mm, Ø approx. 110 mm
- weight approx. 900 gr

Art.-No.	EAN	Colours
TSB 2595 MA S	40 03482... 15820 3	1 polished, black marble
TSB 2595 MA W	15830 2	1 white poliert



TSB 2595 MA S



TSB 2595 MA W

Solid doorstop

- no screwing necessary
- flexible utilisation
- high weight through a solid steel core
- rubber rings and rubber pad for careful and secure stopping
- CR: chromium-plated
- Ni: stainless steel look
- height 35 mm, Ø ca. 95 mm
- weight approx. 1300 gr

Art.-No.	EAN	Colours
TSB 2590 Ni	40 03482... 15910 1	1 stainless steel look



TSB 2590 Ni

Doorstop cone

- nicely shaped and effective doorstop
- chromium steel - rustproof
- no screwing necessary - flexible utilisation
- base and cap made of hard rubber for careful and secure stopping
- Ø 85 mm, height: 62 mm, weight: 1050 gr



Art.-No.	EAN	Colours
TSB 2585 CR	40 03482... 15920 0	1 chrome steel



Due to its special construction and the high rubber cap, the doorstop TSB 2585 is specially suitable for balcony doors or window leaves, which have a larger distance to the floor or to the window sill.



TSB 2585 CR

Solid doorstop

- for wall fixing
- stainless steel
- length 90 mm
- incl. fixing material
- Ø 51 mm



Art.-No.	EAN	Colours
TSW 2390 Ni	40 03482... 15531 8	5 stainless steel



TSW 2390 Ni

Design door wedge

- made of stainless steel
- dimensions H x W x D : 32 x 66 x 153 mm



Art.-No.	EAN	Colours
TKL 2155 Ni	40 03482... 14491 6	3 stainless steel



TKL 2155 Ni



TWM 2495 Ni

Magnetic doorstop

- for wall fixing
- stops and holds the door
- stainless steel appearance, brushed, varnished
- 95 mm long
- Ø 33/45 mm
- incl. fixing material



Art.-No.	EAN		Colours
TWM 2495 Ni	40 03482... 15721 3	3	stainless steel appearance



TSB 2140 Ni

Design doorstop

- for floor fixing
- stainless steel appearance, brushed, varnished
- Ø 40 mm, height 26 mm
- incl. fixing material



Art.-No.	EAN		Colours
TSB 2140 Ni	40 03482... 15661 2	5	stainless steel appearance

TSB 2145 MP



TSB 2145 Ni

Elegant doorstop

- elegant design
- brass polished or stainless steel appearance, brushed, varnished
- Ø 45 mm, height 25 mm
- incl. fixing material



Art.-No.	EAN		Colours
TSB 2145 MP	40 03482... 15641 4	5	brass
TSB 2145 Ni	15651 3	5	stainless steel appearance



TWB 2230 Ni

Modern doorstop

- for wall and floor fixing
- stainless steel appearance, brushed, varnished double buffered
- Ø 30 mm, height 44 mm
- incl. fixing material



Art.-No.	EAN		Colours
TWB 2230 Ni	40 03482... 15711 4	5	stainless steel appearance

